

eureka!

Invented for the way you clean™

3281 Series

OWNER'S GUIDE

Guía del Propietario

Le Guide du Propriétaire



Upright Vacuum Cleaner
Household Type
Aspiradora vertical
tipo doméstico
Aspirateur vertical
de type résidentiel

Thank you for purchasing your new Eureka Vacuum!
¡Gracias por la compra de su nueva aspiradora Eureka!
Merci d'avoir acheté votre nouvel aspirateur Eureka!

**Before Returning, Call
Eureka Customer Service**

Antes de enviar de regreso, llame al Servicio al Cliente de Eureka

Avant de le retourner, appelez le service à la clientèle Eureka

HELPLINE LÍNEA DE AYUDA LIGNE D'AIDE

1-800-282-2886



8 a.m. to 7:30 p.m. (CST), Monday - Friday
10 a.m. to 6:30 p.m. (CST), Saturday - Sunday

8 a.m. a 7:30 p.m. (CST), de lunes a viernes
10 a.m. a 6:30 p.m. (CST), sábado y domingo

8 h à 19 h 30 (CST), lundi au vendredi
10 h à 18 h 30 (CST), samedi et dimanche

Promotional code: Code 3280Ser09

Special Offer – receive 15% off parts and accessories when ordering online. Promotion excludes vacuums.

Oferta especial – descuento de 15% cuando compre partes y accesorios por internet. Oferta excluye aspiradoras.

Offre spéciale – recevez 15% de réduction sur les pièces et les accessoires lorsque vous commandez en ligne. La promotion exclut les aspirateurs.

www.eureka.com

Where to Find Important Vacuum Information

Keep this information

Write the model, type and serial number here:

Date of purchase (keep your receipt) _____

Model number and type _____

Serial number _____

Find these numbers on a label on the lower back side of the vacuum cleaner. Refer to these numbers when ordering parts and accessories or if service is needed.



Before You Start Your Vacuum Cleaner

Refer to **Quick Start Guide** for assembly and use. This **Owner's Guide** provides important instructions to prolong the life of your Eureka vacuum cleaner.

Inspection

Carefully unpack and inspect your new Eureka vacuum cleaner for shipping damage. Each unit is tested and thoroughly inspected before shipping. For instructions regarding any shipping damage, call Eureka Customer Service **HELPLINE 1-800-282-2886** immediately.

Table of Contents

Important Safeguards	1
How to Identify Parts of Vacuum Cleaner	2
Maintenance Schedule	2
Dust cup, filter, screen and HEPA filter.	
How to Use Accessories	3
Crevice tool, extension wand, dusting brush, bare floor nozzle, turbo nozzle and stair hose.	
How to Maintain Your Vacuum Cleaner	4
Maintain brush roll, replace EXT-U brush roll belt and change light bulb.	
How to Clear a Blockage	5
Hose blockages.	
Eureka Limited Warranty Information	5
Thermal Cut-Off and Problem Solving	6
Spanish Owner's Guide	7-13
French Owner's Guide	14-20
Order Forms and Parts List	21-22



Follow caution information wherever you see this symbol.

IMPORTANT SAFEGUARDS

When using an electrical appliance, basic precautions should always be followed, including the following:

READ ALL INSTRUCTIONS BEFORE USING THIS VACUUM CLEANER WARNING

To reduce the risk of fire, electric shock, or injury:



- Do not use outdoors or on wet surfaces.
- **Do not leave vacuum cleaner when plugged in.** Turn off the switch and unplug the electrical cord when not in use and before servicing.
- Do not allow to be used as a toy. Close attention is necessary when used by or near children.
- Use only as described in this manual. Use only manufacturer's recommended attachments.
- Do not use with damaged cord or plug. If vacuum cleaner is not working as it should, has been dropped, damaged, left outdoors, or dropped into water, return it to a service center before using.
- Do not pull or carry by cord. Do not use cord as a handle. Do not close a door on cord or pull cord around sharp edges or corners. Do not run vacuum cleaner over cord. Keep cord away from heated surfaces.
- Do not use extension cords or outlets with inadequate current carrying capacity.
- Turn off all controls before unplugging.
- Do not unplug by pulling on cord. To unplug, grasp the plug, not the cord.
- Do not handle plug or vacuum cleaner with wet hands.
- Do not put any object into openings. Do not use with any opening blocked; keep free of dust, lint, hair, and anything that may reduce airflow.
- This vacuum cleaner creates suction and contains a revolving brush roll. Keep hair, loose clothing, fingers, and all parts of body away from openings and moving parts.
- Do not place vacuum cleaner on furniture or stairs as the brush roll may cause damage. Use extra care when cleaning stairs. Place vacuum cleaner on floor with the handle in storage position while using attachments.
- Do not pick up anything that is burning or smoking, such as cigarettes, matches, or hot ashes.
- Do not use without dust cup, filter and screen, and HEPA exhaust filter in place.
- Belt pulleys can become hot during normal use. To prevent burns, avoid touching the belt pulley when servicing the drive belt.
- Do not use to pick up flammable or combustible liquids such as gasoline, or use in areas where they may be present.
- Store your vacuum cleaner indoors in a cool, dry area.
- Keep your work area well lighted.
- Unplug electrical appliances before vacuuming them.
- Unplug before connecting turbo nozzle.

SAVE THESE INSTRUCTIONS

To reduce the risk of electric shock, this appliance has a polarized plug (one blade is wider than the other). This plug will fit in a polarized outlet only one way. If the plug does not fit fully into the outlet, reverse the plug. If it still does not fit, contact a qualified electrician to install the proper outlet. Do not change the plug in any way.



Motor

Do Not Oil the motor or the brush roll at any time. The bearings are permanently lubricated and sealed.

How to Identify Parts of Vacuum Cleaner

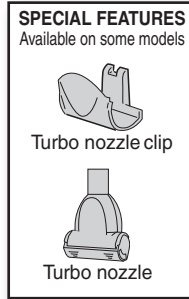

Maintenance Schedule

Maintenance Schedule is also located on back side of dust cup.

! READ ALL INSTRUCTIONS BEFORE USING THIS VACUUM CLEANER. Moving parts! Make sure power switch is in OFF (O) position before plugging in power cord.

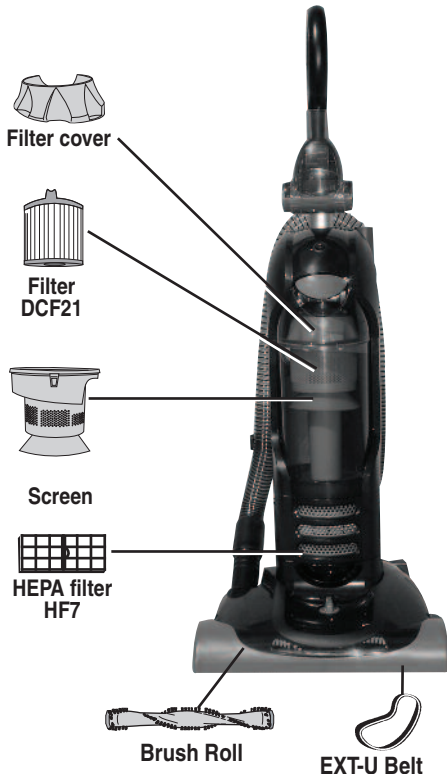

DUST CUP – Empty after each use



FILTER DCF21 – Clean or replace regularly, to maintain suction

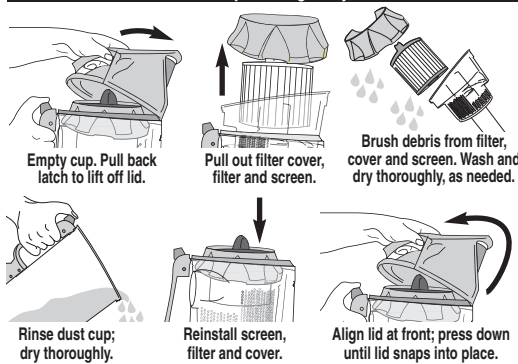

HEPA FILTER HF7 – Replace within 6 months

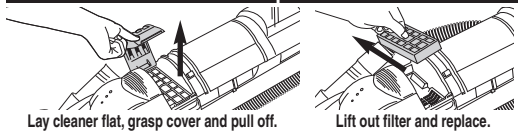

BRUSH ROLL – Clean monthly





How to Use Accessories

Handle must be in upright position.

Raise height adjustment to 'high carpet' before using accessories.

Replace hose end into hose retainer after using accessories.

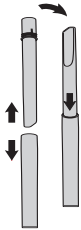

Crevice Tool and Extension Wand

Use for baseboards and corners.

Grasp crevice tool and wand near ridges and pull apart. Push crevice tool into wand and place on end of hose.

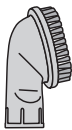

Dusting Brush

Use for furniture, drapes and vents.

Place dusting brush on end of hose, wand or crevice tool.

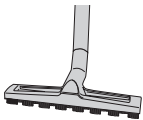
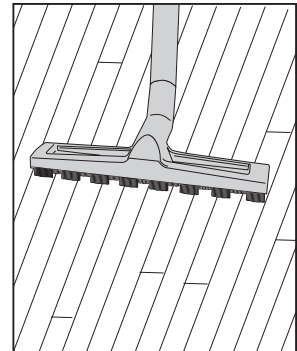
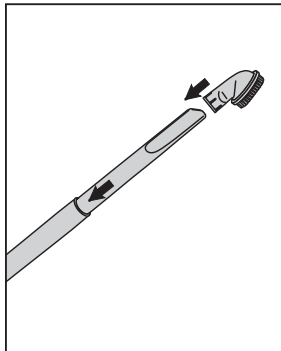

Bare Floor Nozzle and Wand

(with some models or available for purchase)

Use for hard surfaces.

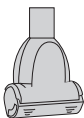
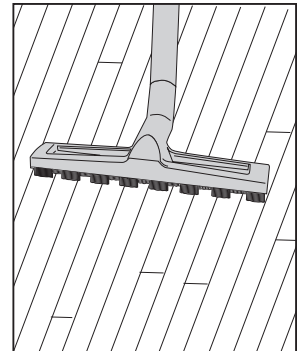
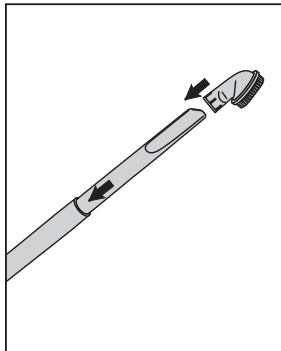

Turbo Nozzle and Stair Hose

(with some models or available for purchase)

Use for furniture and stairs.

Make sure vacuum is below you, pushed against the bottom step.

- 1) If model has additional stair hose, attach to end of hose.
- 2) Attach turbo nozzle to the end of wand and hose.

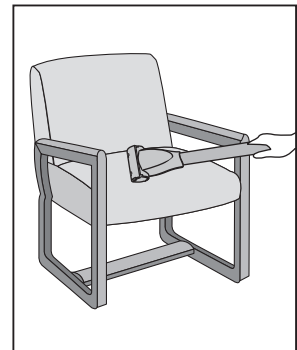



How to Maintain Your Vacuum Cleaner

Make sure vacuum cleaner is turned off and power cord is unplugged

Maintain Brush Roll



Motor can become hot with normal use.

Do not remove end caps. Remove hair and threads from brush roll periodically.



Check EXT-U Belt. Replace if worn, cut or out of shape

Avoid touching the motor shaft when checking brush roll or belt.

How to replace brush roll or belt

1) Step on handle release to lower handle. Step on release a second time to go to lowest position (Fig. 1).

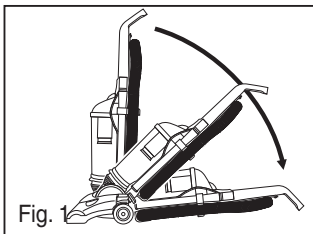

2) Remove 2 screws from brush roll cover. (Fig. 2).

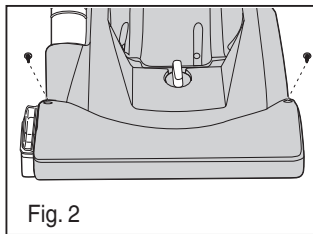

3) Lift off brush roll cover. (Fig. 3).

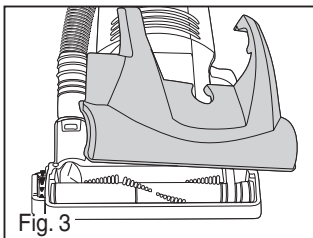

4) Remove brush roll and belt. Thread new belt around motor shaft and brush roll (Fig. 4).

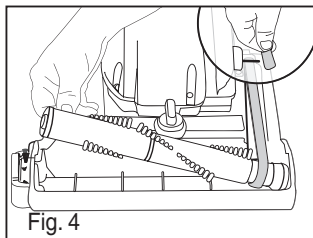

5) Insert left end of brush roll first. Make sure end cap fits into base (Fig. 5). Pull right side of brush roll to stretch belt and insert right end cap into base. Make sure it slides into position.

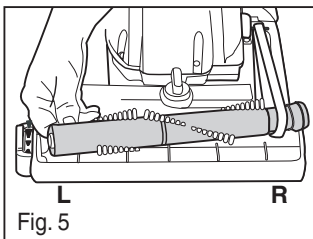

6) Rotate brush roll 2 turns to center belt.

7) Replace brush roll cover (Fig. 3).

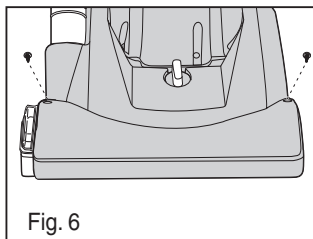

8) Replace 2 screws (Fig. 6).



Change Light Bulb (on some models)

Make sure vacuum is turned off and power cord is unplugged.

1) Lower handle to floor and remove HEPA filter (Fig. 7).

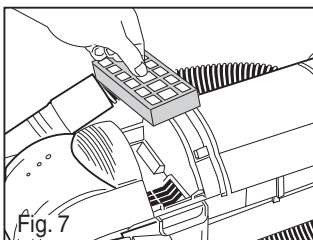

2) Unscrew the lens and remove old bulb. Replace with bulb rated 12v., 10w., Type 904.

3) Push in new bulb, replace lens cover and replace screw (Fig. 8).

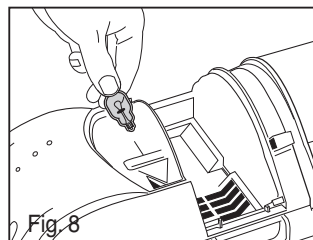

4) Replace HEPA filter and cover; return to upright position.



How to Clear a Blockage

Make sure vacuum is turned off and power cord is unplugged.

Hose Blockage

- 1) Remove hose from hose retainer. Flexing the hose will loosen any blockage (Fig 1).
- 2) **Base hose** – remove 2 screws and brush roll cover. Clear blockage from base hose. Check for debris in brush roll and replace screws and cover (Fig 2).
- 3) **Hose connector** – twist hose from connector. Remove blockage and replace hose. (Fig 3).

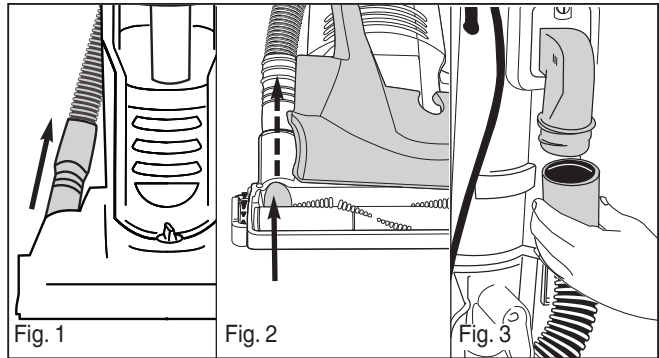

The Eureka Limited Warranty

Eureka warrants this vacuum cleaner to be free from defects in material and workmanship for a term of two years for normal household use. Warranty is granted only to the original purchaser and members of immediate household.

This warranty is good for two years from the date of purchase only when the vacuum cleaner is used in the accordance with Eureka operating instructions.

Note: refurbished or remanufactured products have a one year limited warranty.

This Warranty Does Not Cover

- Parts of the vacuum that require replacement under normal use such as disposable dust bags, filters, drive belts, light bulbs, brush roll, bristles, impellers and cleaning.
- Damages or malfunctions caused by negligence, abuse, and use not in accordance with the Owner's Guide.
- Defects or damages caused by unauthorized service or the use of other than Genuine Eureka, ARM & HAMMER™ and Filtrite™ by 3M parts.

What Eureka Will Do

Eureka will, at its option, repair or replace a defective vacuum or vacuum part that is covered by this warranty. As a matter of warranty policy, **Eureka will not refund the consumer's purchase price.**

Warranty Registration

Please fill out and return the warranty registration card accompanying your vacuum.

Obtaining Warranty Service

To obtain warranty service you must return the vacuum or vacuum part along with "proof of purchase" to any Eureka Authorized Warranty Station. For Eureka

Authorized Warranty Station or Service Information, visit www.eureka.com, write or telephone toll free:

USA: 1-800-282-2886
Electrolux Home Care
North America Service Division
P.O. Box 3900
Peoria, IL 61612

Mexico: (55) 5343-4384
Electrolux Home Care

Canada: 1-800-282-2886
Electrolux Home Care
North America Service Division
5855 Terry Fox Way
Mississauga, Ontario L5V 3E4

Obtaining Warranty Service Outside Your Community

You must pay the shipping charges to the Eureka Authorized Warranty Station.

Return Shipping Charges will be paid by the Warranty Station. When returning parts for repair, please include the model, type and serial number located on the rating plate on the lower backside of the vacuum.

Further Limitations and Exclusions

Any warranty that may be implied in connection with your purchase or use of the vacuum, including any warranty of Merchantability or any warranty for Fitness For A Particular Purpose is limited to the duration of this warranty. Some states do not allow limitations on how long an implied warranty lasts, so the above limitations may not apply to you.

Your relief for the breach of this warranty is limited to the relief expressly provided above. In no event shall the manufacturer be liable for any consequential or incidental damages you may incur in connection with your purchase or use of the vacuum.

Some states do not allow the exclusion or limitation of incidental or consequential damages, so the above limitation or exclusion may not apply to you.

This warranty gives you specific legal rights. You may also have other rights, which may vary by state.

The ARM & HAMMER name is a trademark of Church and Dwight Co., Inc. 3M and Filtrite are trademarks of 3M Company, used by Electrolux Home Care Products, Inc. under license.

Thermal Cut-Off

This vacuum cleaner has a special thermostat that protects the vacuum in case of motor overheating. If the vacuum suddenly shuts off, push the power switch to off (O) and unplug the vacuum. Check the vacuum for a possible source of overheating such as a full dust cup, blocked hose or clogged filter. If these conditions are found, fix them and wait at least 30 minutes before attempting to use the vacuum. After the 30 minute period, plug the vacuum back in and turn on the switch. If the vacuum still does not work, take it to a Eureka authorized service center for repair or call 1-800-282-2886.

Problem Solving

 **Make sure vacuum is turned off and power cord is unplugged.**

Problem	Cause	Solution
Motor will not start.	Power plug	<ul style="list-style-type: none"> • Push plug securely into outlet, try another outlet or check circuit breaker.
	Power switch	<ul style="list-style-type: none"> • Turn power switch to on (I).
	Thermal cut-off	<ul style="list-style-type: none"> • See above.
Vacuum does not clean carpet or bare floor.	Dust cup and filter	<ul style="list-style-type: none"> • Empty dust cup, clean and/or change filter. • Clean or replace filters regularly to maintain suction. Page 2 • If picking up fine dust, the dust cup may not look full, but a fine substance tends to reduce suction when it blocks air flow through the filter and screen. Refer to page 2 for filter maintenance. Make sure filter, screen and dust cup are installed properly.
	Belt	<ul style="list-style-type: none"> • Replace a worn, cut or out of shape belt. Page 4
	Hose	<ul style="list-style-type: none"> • Remove clogs from the hose that restrict the airflow. Make sure hose is replaced into hose retainer. Page 5
	Bare floor setting	<ul style="list-style-type: none"> • For bare floor cleaning, turn height adjustment knob to bare floor position.
	Carpet height setting	<ul style="list-style-type: none"> • For carpet cleaning, turn height adjustment knob to another position.
No suction at the end of hose.	Dust cup and filter	<ul style="list-style-type: none"> • Empty dust cup, clean and/or change filter. • Clean or replace filters regularly to maintain suction. Page 2 • If picking up fine dust, the dust cup may not look full, but a fine substance tends to reduce suction when it blocks air flow through the filter and screen. Refer to page 2 for filter maintenance. Make sure filter, screen and dust cup are installed properly.
	Hose	<ul style="list-style-type: none"> • Remove clogs from the hose that restrict the airflow. Make sure hose is replaced into hose retainer. Page 5
Turbo nozzle will not turn.	Rotating brush	<ul style="list-style-type: none"> • Check turbo nozzle for debris.
Vacuum is hard to push.	Vacuum height setting	<ul style="list-style-type: none"> • Adjust knob to a higher position.
	Belt	<ul style="list-style-type: none"> • Replace a worn, cut or out of shape belt. Page 4
Burning smell; brush roll will not turn.	Belt	<ul style="list-style-type: none"> • Check brush roll for debris. Page 4
		<ul style="list-style-type: none"> • Replace broken or out of shape belt. Page 4